

Dielectric-fibre surface waveguides for optical frequencies

K.C. Kao and G.A. Hockham

Indexing terms: Optical fibres, Waveguides

Abstract: A dielectric fibre with a refractive index higher than its surrounding region is a form of dielectric waveguide which represents a possible medium for the guided transmission of energy at optical frequencies. The particular type of dielectric-fibre waveguide discussed is one with a circular cross-section. The choice of the mode of propagation for a fibre waveguide used for communication purposes is governed by consideration of loss characteristics and information capacity. Dielectric loss, bending loss and radiation loss are discussed, and mode stability, dispersion and power handling are examined with respect to information capacity. Physical-realisation aspects are also discussed. Experimental investigations at both optical and microwave wavelengths are included.

List of principle symbols

J_n = n th-order Bessel function of the first kind
 K_n = n th-order modified Bessel function of the second kind 2π
 β = $\frac{2\pi}{\lambda g}$, phase coefficient of the waveguide
 J'_n = first derivative of J_n
 K'_n = first derivative of K_n
 h_i = radial wavenumber or decay coefficient
 ϵ_i = relative permittivity
 k_0 = free-space propagation coefficient
 a = radius of the fibre
 γ = longitudinal propagation coefficient
 k = Boltzman's constant
 T = absolute temperature, K
 β_c = isothermal compressibility
 λ = wavelength
 n = refractive index
 $H_v^{(i)}$ = v th-order Hankel function of the i th type
 H'_v = derivation of H_v
 v = azimuthal propagation coefficient = $v_1 - jv_2$
 L = modulation period
 Subscript n is an integer and subscript m refers to the m th root of $J_n = 0$

1 Introduction

A dielectric fibre with a refractive index higher than its surrounding region is a form of dielectric waveguide which represents a possible medium for the guided transmission of energy at optical frequencies. This form of structure guides the electromagnetic waves along the definable boundary between the regions of different refractive indexes. The associated electromagnetic field is carried partially inside the fibre and partially outside it. The external field is evanescent in the direction normal to the direction of propagation, and it decays approximately exponentially to zero at infinity. Such structures are often referred to as open waveguides, and the propagation is known as the surface-wave mode. The particular type of dielectric-fibre waveguide to be discussed is one with a circular cross-section.

Paper 5033E was originally published in the *Proceedings IEE*, July 1966. It was first received 24th November 1965 and in revised form 15th February 1966.

The authors were formerly with Standard Telecommunication Laboratories Ltd., Harlow, Essex. Prof. Kao is now with ITT and Dr. Hockham is with Plessey Company Ltd., 241 Station Road, Addlestone, Surrey, United Kingdom

2 Dielectric-fibre waveguide

The dielectric fibre with a circular cross-section can support a family of H_{0m} and E_{0m} modes and a family of hybrid HE_{nm} modes. Solving the Maxwell equations under the boundary conditions imposed by the physical structure, the characteristic equations are as follows:

for HE_{nm} modes

$$\frac{n^2 \beta^2}{k_0} \left(\frac{1}{u_1^2} + \frac{1}{u_2^2} \right)^2 = \left\{ \frac{\epsilon_1 J'_n(u_1)}{u_1 J_n(u_1)} + \frac{\epsilon_2 K'_n(u_2)}{u_2 K_n(u_2)} \right\} \times \left\{ \frac{1 J'_n(u_1)}{u_1 J_n(u_1)} + \frac{1 K'_n(u_2)}{u_2 K_n(u_2)} \right\} \quad (1)$$

for E_{0m} modes

$$\frac{\epsilon_1 J'_0(u_1)}{u_1 J_0(u_1)} = - \frac{\epsilon_2 K'_0(u_2)}{u_2 K_0(u_2)} \quad (2)$$

for H_{0m} modes

$$\frac{1 J'_0(u_1)}{u_1 J_0(u_1)} = - \frac{1 K'_0(u_2)}{u_2 K_0(u_2)} \quad (3)$$

The auxiliary equations defining the relationship between u_1 and u_2 are

$$u_1^2 + u_2^2 = (k_0 a)^2 (\epsilon_1 - \epsilon_2)$$

$$h_1^2 = \gamma^2 + k_0^2 \epsilon_1$$

$$- h_2^2 = \gamma^2 + k_0^2 \epsilon_2$$

$$u_i = h_i a, i = 1 \text{ and } 2$$

where subscripts 1 and 2 refer to the fibre and the outer region, respectively.

All the modes exhibit cutoffs except the HE_{11} mode, which is the lowest-order hybrid mode. It can assume two orthogonal polarisations, and it propagates with an increasing percentage of energy outside the fibre as the dimensions of the structure decrease. Thus, when operating the waveguide in the HE_{11} mode, it is possible to achieve a single-mode operation by reducing the diameter of the fibre sufficiently. Under this condition, a significant proportion of the energy is carried outside the fibre. If the outside medium is of a lower loss than the inside dielectric medium, the attenuation of the waveguide is reduced. With these properties, HE_{11} mode operation is of particular interest.

The physical and electromagnetic aspects of the dielectric-fibre waveguide carrying the HE_{11} mode for use at optical frequencies will now be studied in detail. Conclusions are drawn as to the feasibility and the expected

performance of such a waveguide for long-distance-communication application.

3 Material aspects

The losses of the dielectric-fibre waveguide are governed by the bulk losses of the materials which constitute the fibre and the surrounding medium. The relative contribution to the total loss is determined by the proportion of energy within and outside the fibre and the relative losses of the two media. In general, it is desirable to have low bulk losses for both media, in order to achieve a satisfactory fibre waveguide with low attenuation.

3.1 Material-loss characteristics

The bulk loss in dielectrics is caused by absorption and scattering phenomena. The particular mechanism involved differs for each material and depends on the operating wavelength. The material-loss property is to be examined between wavelengths of 100 and 0.1 μm , where the physical size and the information capabilities of the dielectric-fibre waveguide are convenient.

3.1.1 Scattering: Scattering arises as a result of

- (a) lack of order of the structure of the material
- (b) structural defects
- (c) particle inclusion
- (d) random fluctuation.

For crystalline materials, the first two mechanisms are predominant. Polycrystalline materials and materials which are partly amorphous and partly crystalline show lack of order of the structure; this results in high scattering loss. Single-crystal materials are ordered but may have structural defects; if these are few and of small size compared with the wavelength, the scatter loss may not be very high. However, such materials are usually difficult to obtain in long lengths.

For amorphous materials, such as organic polymers and inorganic glasses, mechanisms (c) and (d) are more important. Organic polymers often contain all-chemical dust particles much larger than 1 μm in diameter, caused by the uncontrolled environment in which they are manufactured. This undesirable feature is likely to be eliminated by the use of a dustfree environment and freshly redistilled monomers and catalysts during manufacture. For inorganic glasses, the temperatures involved are high enough to cause chemical decomposition of most particle inclusion, resulting in such particles appearing as impurity centres.

The glassy state is a result of the supercooling of a liquid; thus the glassy-state solid retains some of the fundamental behaviour of the liquid state. Therefore localised material-density fluctuation can take place. The scattering due to this can be described by the following expression [2]:

$$36 \times 10^3 \frac{(n-1)^2}{\lambda^4} kT\beta_c \text{ decibels per metre}$$

For inorganic glass with a fictive temperature of 1000°C, the scattering loss is of the order of 1 dB/km. Fictive temperature is the temperature at which glass viscosity has increased to a value where the glass is regarded as a solid.

Crystallite formation is a structural defect for glassy-state materials. The sizes of the crystallites in a glassy material can be controlled by the rate of cooling. For a fibre, the rate of cooling is high; this results in fewer and smaller crystallites. The scattering due to crystallites in rapidly cooled glasses obeys the Rayleigh scattering law;

i.e. loss is proportional to λ^{-4} . It is estimated that the loss is of the order of a few decibels per kilometre at 1 μm wavelength.

3.1.2 Absorption: Absorption bands in solids are usually broad, owing to the close packing of the molecules. They arise from the natural-vibration frequencies of the molecular and electronic systems. Near such frequencies, the energy of the external electromagnetic field couples energy into the vibration of the molecules and electrons. In the wavelength region between 100 and 1 μm , many longitudinal and rotational resonances of molecules are present in almost all substances, especially the long-chain polymers. Strong absorption takes place throughout most of the region. In the 0.3–0.1 μm region, electronic-resonance absorption bands are present. In the intermediate region (i.e. 1–0.3 μm), resonance-absorption phenomena are relatively absent. This represents a region for the material to have low loss.

In inorganic glasses, it is known that absorption can occur owing to the presence of impurity ions. It is known that, in high-quality optical glasses, the main contribution to absorption loss in the 1–3 μm region is due to the Fe^{++} and Fe^{+++} ions. The ferrous ion has an absorption band centred at about 1 μm , while the ferric ion has one at about 0.4 μm . At band centre, the absorption due to 1 part per million of Fe^{++} in certain glass systems³ is estimated to result in an absorption coefficient of less than 20 dB/km.

3.1.3 Present state of low-loss material: The present known low-loss materials in the frequency range of interest are mainly in the visible part of the spectrum. This is because transparent materials in this frequency range have been in high demand. The best transparent materials known in the visible spectrum are high-quality optical glasses, fused quartz, polymethyl methacrylate and polystyrene. The best absorption coefficient for glass is reported as 0.05% per cm, which is equivalent to $\tan \delta = 1 \times 10^{-8}$ at 1 μm , giving a bulk loss of about 200 dB/km. The published data on polymethyl methacrylate give 0.2% per cm, equivalent to a bulk loss of about 600 dB/km at 0.7 μm wavelength. This is for a commercial-grade material which is known to suffer from high particle-scattering losses.

Typical absorption/wavelength curves can be seen in Figs. 1, 2 and 3, showing the measurements made on glass,

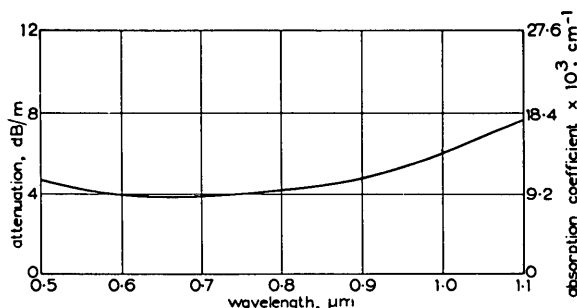

Fig. 1 Attenuation in SW6 glass

quartz and polymethyl methacrylate samples, respectively. Work is in progress towards obtaining lower-absorption glasses. Currently this is being given an additional boost, owing to laser-glass requirements. It is foreseeable that glasses with a bulk loss of about 20 dB/km at around 0.6 μm will be obtained, as the iron-impurity concentration may be reduced to 1 part per million.

4 Electromagnetic aspects

The choice of the mode of propagation for the fibre waveguide used for communication purposes is governed by the

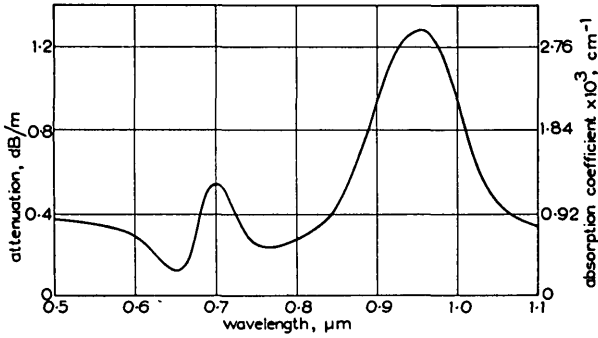

Fig. 2 Attenuation in fused quartz

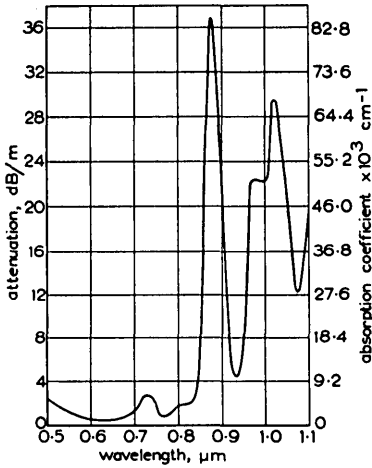

Fig. 3 Attenuation in polymethyl methacrylate

consideration of loss characteristics and information capacity.

4.1 Dielectric loss

For a fibre-dielectric waveguide with free space as its lossfree outside medium, it is an advantage to choose the radius, the dielectric constants and the mode of propagation so that the ratio of the energy in free space to the energy in the dielectric fibre is large. Examining the characteristic eqn. 1 of this system, it can be shown that the radial-decay coefficient in the outside medium decreases when a particular mode is near cutoff, corresponding to the proportion of energy in the outside region increasing. The characteristics of the E_0 , H_0 and HE_{11} modes are shown in Figs. 4 and 5; the effective losses in decibels are shown in Figs. 6 and 7.

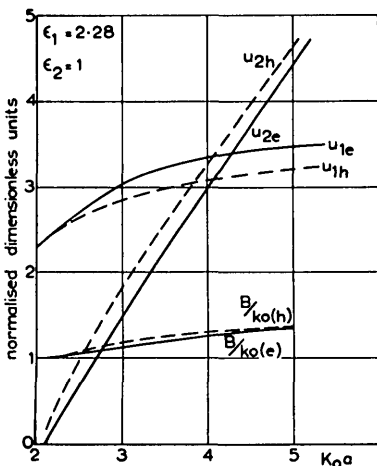

Fig. 4 H_0 and E_0 mode characteristics

This improvement in loss characteristics has already been explored at microwave frequencies [4], the E_0 mode

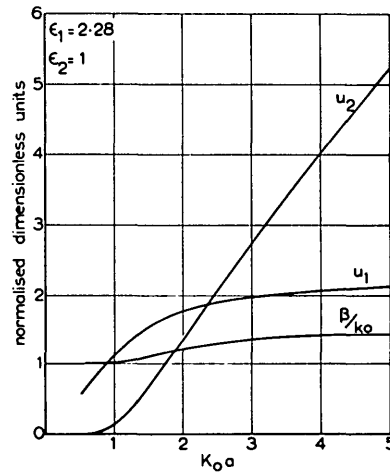

Fig. 5 HE_{11} mode characteristics

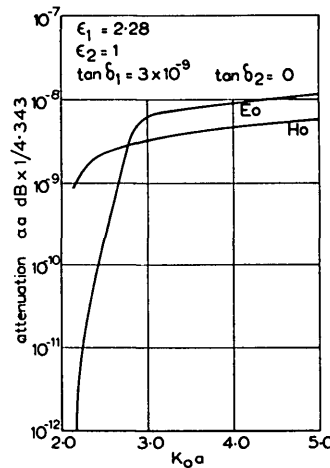

Fig. 6 H_0 and E_0 attenuation

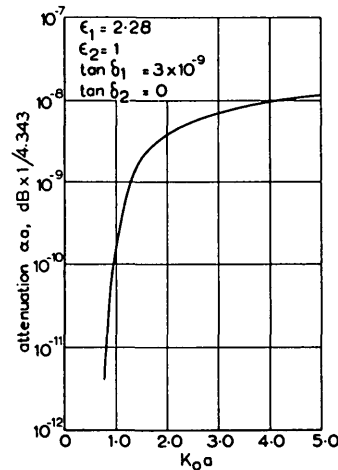

Fig. 7 HE_{11} mode attenuation

has been used. In the microwave region, the waveguide is a few millimetres in radius. Supporting structures much smaller in size than the operating wavelength may be designed for minimum reflection and radiation losses. The radial-decay coefficient is usually designed to give the lowest effective attenuation coefficient while allowing the waveguide to negotiate bends without appreciable radiation. This aspect will be discussed later.

At the visible wavelengths, the operation of a dielectric waveguide with free space as its outer medium is difficult. The physical size, which is now in the submicron range, becomes a serious snag for exploring the advantage of loss

reduction. The radius for low-loss operation is considerably less than the wavelength — usually about one tenth. This will cause the waveguide to be invisible, even with the aid of optical instruments. Supports, of smaller than the wavelength dimensions, no longer exist. Furthermore this size may present problems in power handling and mechanical strength. Thus, for optical frequencies, a cladded structure is necessary, in which the dielectric fibre is covered with a concentric layer of a second dielectric of lower permittivity. With the cladding thickness made equal to many wavelengths, usually taken to be about 100, the field at the external boundary may be made arbitrarily small. The waveguide may then be easily supported. For the cladded fibre, the choice of the mode of propagation is on an information basis.

4.2 Bending loss

When a surface waveguide follows a curved path, radiation of the guided energy occurs. Exact analysis of this effect for a fibre-dielectric waveguide is difficult, as the partial differential equation of the system is variable inseparable. Radiation from a curved infinite strip of constant radius of curvature has been solved [5, 6]. It is shown that the characteristic equation describing the system is

$$\frac{1}{\sqrt{\epsilon_i}} \frac{\{H_v^{(1)}\}'(kB)\{H_v^{(2)}\}'(kA) - \{H_v^{(2)}\}'(kB)\{H_v^{(1)}\}'(kA)}{H_v^{(1)}(kB)\{H_v^{(2)}\}'(kA) - H_v^{(2)}(kB)\{H_v^{(1)}\}'(kA)} = \frac{\{H_v^{(2)}\}'(k_0 B)}{H_v^{(2)}(k_0 B)} \quad (4)$$

where $k = k_0 \sqrt{\epsilon_i}$

A = inner radius

B = outer radius

A is the radius along the centre of the dielectric where symmetry on either side is still assumed to hold. This is valid for $2t/A \ll 1$, where t is the film thickness. This has been solved approximately previously; the results showed that the radiation loss as a function of bending radius is a fast varying function. The results quoted from Reference 5 are in Table 1. They show that bending loss is negligible until a certain critical radius of curvature is reached, when the bending loss becomes very large. The critical radius is dependent on the transverse-decay coefficient. It is convenient to define the critical radius as the radius of curvature at which the loss is X dB/rad. X may be fixed arbitrarily at, say, 0.01. With a small transverse-decay coefficient, the

Table 1: Characteristic of curved surface waveguide [5]

$K_0 A$	$\beta_0 A$	γA
60	63	64 + 0.9j
	66	66.1 + 0.3j
	75	75 + 10 ⁻⁴ j
	90	90 + 10 ⁻¹⁴ j
120	126	126.4 + 0.8j
	132	132 + 0.03j
	150	150 + 10 ⁻¹¹ j
	180	180 + 10 ¹¹ j
	480	504
528	528	528 + 10 ⁻¹⁰ j
	600	600 + 10 ⁻¹⁰ j
	720	720 + 10 ⁻¹³² j
	960	1008
1056	1056	1056 + 10 ⁻²² j
1200	1200	1200 + 10 ⁻⁹⁴ j
1440	1440	1440 + 10 ⁻²⁶⁸ j

β_0 = propagation coefficient at infinite radius of curvature
 $\gamma = (\beta_0 + \Delta\beta + j\alpha) =$ propagation coefficient of curved waveguide
 A = radius of curvature

energy extends a long way from the surface of the strip. The energy is loosely coupled to or trapped in the waveguide. Under this condition, a small curvature will cause large radiation loss; i.e. the critical radius is large.

The decay coefficient of a fibre-dielectric waveguide, for equal ratio of energy outside to the inside, is larger than that of the infinite-strip case. It suggests that the bending loss of the fibre is likely to be smaller than that of the equivalent film. The critical radius of curvature with an energy ratio of 100 : 1 is around 1000 λ . This, at visible wavelength, is a very sharp physical bend.

4.3 Other losses due to radiation

Physical discontinuities of the dielectric waveguide cause guided-energy loss by radiation. The step discontinuity for the fibre waveguide has been solved [7] for the cases of the symmetrical E_0 modes and the hybrid HE_{11} mode. The discontinuity was represented by a change in the surface reactance of the structure; a Wiener-Hopf method was employed. The result can be summarised as follows.

The radiation occurs within a range of angles with the peak at some particular value. For the same ratio of reactances, the angle of elevation for peak radiation is larger for the case of higher trapping. The radiation is almost entirely confined to the forward direction. The radiated energy is around 7% for a reactance change of 10 times; for a 3-times reactance change, the energy radiated is 1%. The transmitted power for these cases is 93 and 99%, respectively, showing that little reflected power is present.

Cyclic dimensional changes occur frequently in a fibre waveguide. The case of the sinusoidal surface-reactance change can be analysed rigorously. Solutions for the symmetrical E_0 mode and the hybrid HE_{11} mode can be obtained by a transform method [8]. The results show that the electro-magnetic radiation supported by the structure can be expressed in a spectrum of space-harmonic waves of the modulating period. Most of the component waves are trapped, some are forward-propagating and some are backward-propagating; some, however, are radiative. The power contained in the space-harmonic components decreases with the order of the harmonic, except at certain conditions which are described in detail in Reference 8. The main contribution is due to the first three components; for the case of the E_0 mode it is as shown in Fig. 8. The radiation is dependent on the modulation depth; to

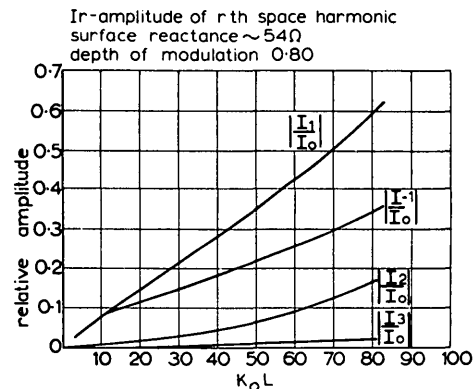

Fig. 8 Space-harmonic amplitude distribution

a first approximation, it is proportional to the square of the modulation depth.

For more complicated waveforms, the main contribution is likely to be from the period with the largest modulation depth. For waveforms of two or more equal-magnitude sinusoids, the superposition is difficult to predict, owing to the existence of mutual couplings. An analysis with random discontinuity has been reported [9],

but the results have not been confirmed. The extension of this method to the periodic case did not yield results in agreement with those obtained by the rigorous solution. The loss due to random discontinuity is intuitively anticipated to be low. This, of course, needs further theoretical and experimental verification.

4.4 Information capacity

Three factors affect the information capacity of a waveguide structure — mode stability, dispersion and power handling.

4.4.1 Mode stability: The mode stability of a waveguide is dependent on the physical and material perfection of the waveguide. Any imperfection appears as a form of discontinuity which causes mode conversion. In the case of a single-mode waveguide the process of mode conversion gives rise to localised fields, resulting in mainly radiation. When a single mode can exist in more than one polarisation, a discontinuity may couple some power from one to the other polarisation configuration. In the case of an overmoded waveguide, the mode conversion may result in radiation as well as the excitation of propagating modes other than the incident mode. This gives rise to a multi-mode phenomenon.

At some later discontinuity, mode reconversion can take place. As the modes propagate at different velocities, information distortion takes place. In the single-mode waveguide, reconversion between different polarisation can take place. However, as the modes are travelling with the same group velocity, distortion does not take place, owing to incorrect phasal addition. Nevertheless, if the detector is polarisation-sensitive, amplitude distortion results. Thus, for high information capacity, a single-mode waveguide is desirable. It is sometimes preferable to have a mode which has only one polarisation. For the dielectric-fibre waveguide, this favours E_0 , H_0 or HE_{11} modes, although the HE_{11} mode has two possible polarisations.

4.4.2 Dispersion: The dispersion characteristics of dielectric-fibre waveguides have two regions of interest. One region corresponds to operating the waveguide far removed from cutoff. Thus, for a highly overmoded waveguide, extremely flat phase characteristics can be obtained, giving good dispersion characteristics. This, however, is not desirable, on account of mode instability. The other region occurs when the waveguide is operating very near to cutoff. The waveguide wavelength is then nearly equal to the free-space wavelength. The phase characteristics for the modes becomes flatter as the order of the mode decreases. This condition offers single-mode operations for the E_0 , H_0 and HE_{11} modes. The HE_{11} mode dispersion characteristic is the best. The group-delay distortion for a 10 km route, using the HE_{11} mode under the operating condition when the $k_0 a = 0.6$, can be estimated as follows.

From the slope of the ω/β plot, the slope change over 1 Gc/s is taken to be approximately 10^{-6} . Assuming that the refractive-index change with frequency is negligible, the group delay is given approximately by

$$\begin{aligned} & \text{distance} \times \text{velocity}^{-1} \times \text{slope change} \\ &= 10 \times 10^9 \times \frac{1}{3 \times 10^{14}} \times 10^{-6} = \frac{1}{3} \times 10^{-10} \text{ s} \end{aligned}$$

This represents a 24° phase shift for 1 GHz bandwidth.

4.4.3 Power handling: Assuming single-mode operation, the power-handling capacity is determined by the breakdown condition of the fibre waveguide when subjected to

high power density. For a particular wavelength operation, the single-mode-waveguide size needs to be smaller than the cutoff dimension. If the maximum power density is 50 MW/cm^2 , the maximum permissible power input for single-mode (HE_{11}) operation must be less than $5\pi(0.338\lambda_0)^2 \times 10^2$. For $\lambda_0 = 0.74 \mu\text{m}$, the power must be less than 100 mW. Considering the case when the signal/noise ratio is to be not less than 20 dB and loss between repeaters is 50 dB, this will mean that the signal/noise ratio at input is to be 70 dB above noise.

The noise at optical frequencies is mainly quantum noise, and it is given approximately by $h\nu B$, where h is Planck's constant, ν is the frequency and B is the bandwidth. For $B = 1 \text{ kHz}$, this is approximately equal to 100 dB, below 1 mW. Hence the bandwidth for a 100 mW input power is 100 MHz. By increasing the permittivity of the outer medium to approach that of the inner, the power-handling capacity can be made to increase. For a waveguide with index matching of 1%, the power handling is increased by about ten times; this will enable the information capacity to increase to 1 GHz.

5 Physical aspects

The material-loss characteristic is an important physical aspect which has already been discussed. There are further requirements on the material properties for fibre-waveguide application. These are the fabrication and mechanical strength.

5.1 Fabrication

The fabrication of dielectric-fibre waveguides is a process of pulling or extrusion. For inorganic glasses, the molten glass is allowed to flow through an orifice, often at the end of a cone structure. The end is attached to a pulling device and the material is drawn in the plastic state; it is then allowed to cool rapidly. Owing to the high surface-tension energy involved in the plastic state, the resulting fibre has very good cylindrical symmetry. The rapid cooling causes the high-temperature liquid-state properties to be retained. The surface of the fibre is particularly good when freshly made; a tensile strength of 10^6 lbf/in^2 is possible. Surface deterioration due to atmospheric attacks and external mechanical influences cause a rapid decrease in the mechanical strength. For organic dielectric fibres, similar processes take place, although the surface forces are now smaller. The surface perfection still gives very high tensile strength.

In the case of cladded fibre, the interface between the outer and inner materials is protected. Although the strength is dependent mainly on the perfection of the outer surface, the inner surface contributes to the overall strength. In any case, the cladded structure usually has an outer/inner-dimension ratio of 100 : 1, and hence derives its strength from the relatively large bulk of material present.

The physical tolerance of the single fibre is dependent on the variation of the rate of pulling. With a constant speed of pulling and a constant rate of flow, the practical tolerance achievable at present is claimed to be about 5%; with more refinement this may be improved. For cladded fibre, the overall tolerances and the ratio of the outer to inner diameters may again be made to meet a 5% tolerance limit. In the cladded fibre, the boundary between the inner and the outer materials is not likely to be an abrupt transition. A diffusion process necessarily takes place when the two streams are flowing in the liquid state. This causes a graded junction to be formed. Thus the important

guiding boundary of the clad structure is not only protected but also graded. This gives rise to even less stringent tolerance requirements; however, the formation of a scattering centre in this region may exist.

The dependence of tolerance requirements on the variation of surface reactance can be calculated [8]. Numerical calculations for three separate radii are as follows:

$$a = a_1, \alpha = 0.00018$$

$$a_2 = 1.1a_1, \alpha = 0.003$$

$$a_3 = 1.2a_1, \alpha = 0.096$$

a_1 is chosen to be equivalent to a normalised surface reactance of 0.038 for a constant modulating depth of 0.8. This shows that dimensional tolerances become less critical with the decrease in fibre inner diameter.

6 Experimental investigations

In electromagnetic investigations, the experiments were carried out at some convenient microwave frequencies. The system measurements were carried out at visible and near-infrared wavelengths.

6.1 Microwave scaled measurements

The corrugated metallic rods [10, 11], with corrugated pitch much smaller than the operating wavelength, are used to simulate the dielectric-fibre waveguide. To a first approximation, the surface reactance of such a waveguide is derived by considering only the fundamental space harmonic. The choice of this type of waveguide, as opposed to dielectric rods, is the ease of accurately machining such a modulated-surface reactance rod. The required tolerance of about 0.0005 in (0.013 mm) is difficult, if not impossible, to achieve on a dielectric structure. Measurements were carried out at X band frequencies (i.e. approximately 10 GHz) to assess the radiation loss due to sinusoidal

surface-reactance variations; the effect of bending was also examined. Both E_0 and HE_{11} modes were investigated.

6.1.1 Sinusoidal surface-reactance variation: A parallel-plate surface-wave resonator was used to determine the relative losses of various rods with sinusoidally modulated surface reactances, as shown in Figs. 9 and 10, for the E_0 and HE_{11} modes, respectively. The independent variables are the pitch and the depth of modulation. The apparatus is shown schematically in Fig. 11, and the results are shown in Figs. 12 and 13 for the E_0 and HE_{11} modes, respectively. Both theoretical and experimental results are included.

6.1.2 Bending loss: The bending loss of the corrugated-metal-rod waveguides were measured for the rod carrying the E_0 mode. The result shows that no significant loss can be measured until the bending radius is below a certain figure (Fig. 14). The radius for measurable loss corresponds to less than $100 \lambda_0$.

6.2 Optical experiments

The experiments at optical frequencies were aimed at developing the technique and instrumentation for quantitative assessment of the waveguide performance. The initial experiments were on the launching of waveguide modes. The optical system was as shown in Fig. 15. The light source used was a helium-neon single-transverse-mode laser and a gallium arsenide semiconductor laser. The optical waveguides used were clad fibres with signal-yellow glass as inner core. The refractive-index matching gives single-mode operation at 6328 \AA wavelength when the inner-core diameter is $< 4 \mu\text{m}$. The range of fibre sizes used was $3\text{--}13 \mu\text{m}$. The fibres were mounted in capillary tubes and set in epoxy resin; this enabled the ends to be optically polished. Some of the observed single-mode and multimode field-intensity distributions are

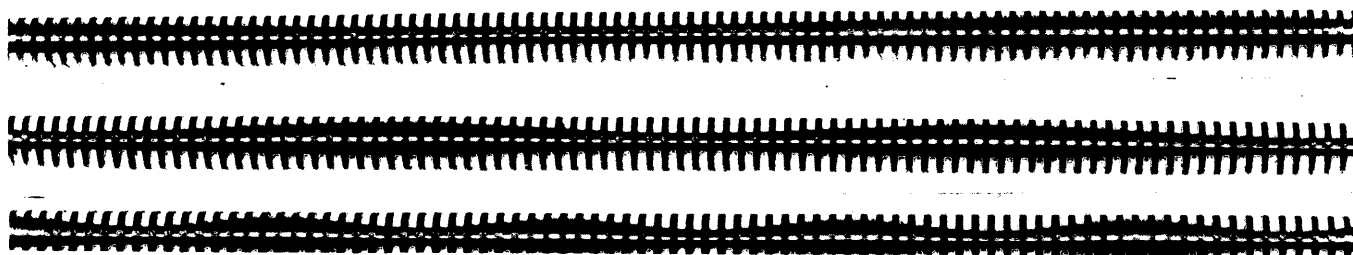

Fig. 9 Corrugated waveguides supporting E_0 modes

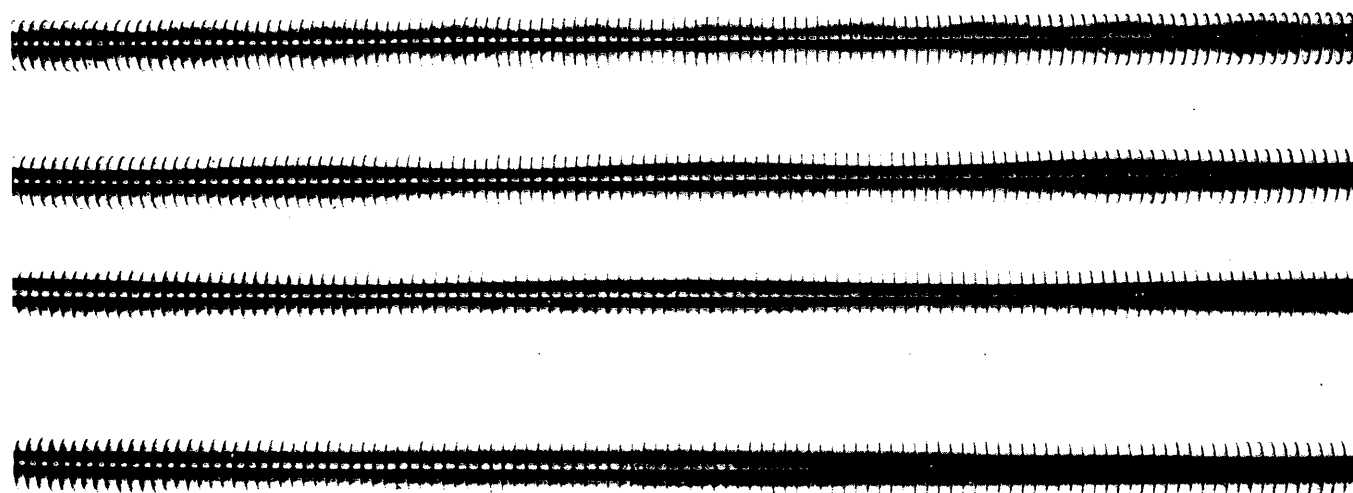

Fig. 10 Corrugated waveguides supporting HE_{11} mode

shown in Fig. 16; the modes have been identified, and these are tabulated in Table 2. Preferential excitation is

suitable lens system, alignment was possible. The observation of modes has been achieved.

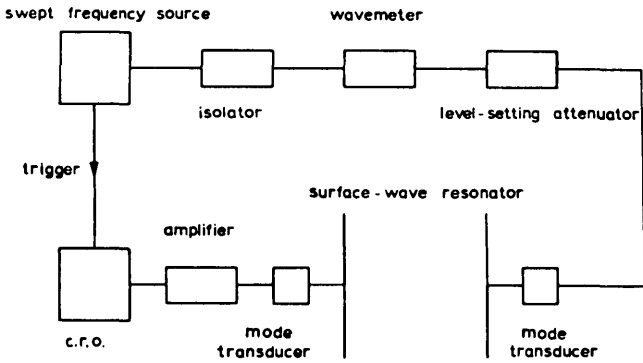

Fig. 11 Microwave measuring equipment

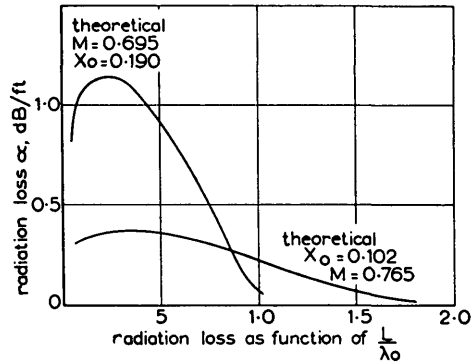

Fig. 13 Radiation loss as a function of L/λ_0 (HE_{11} mode)

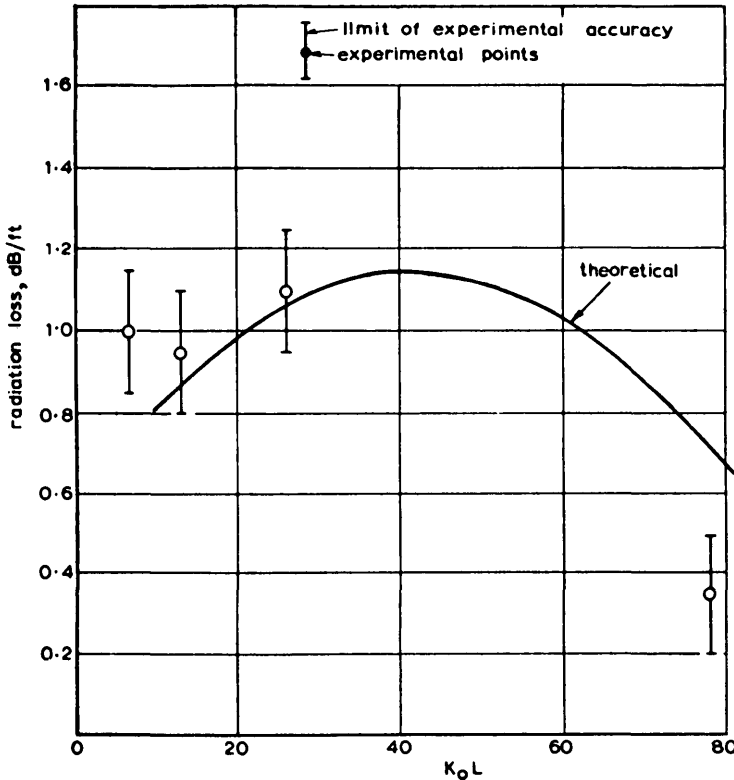

Fig. 12 Radiation loss as a function of $k_0 L$ (E_0 mode)

achieved by the positioning of the light spot and the rotation of the light polarisation. The cutoff of some of the higher-order modes may be observed by using a white-light source through a monochromator. The use of a gallium arsenide laser was aimed at discovering methods of aligning a near infrared system when visual observation cannot be made. With the aid of an image convertor and a

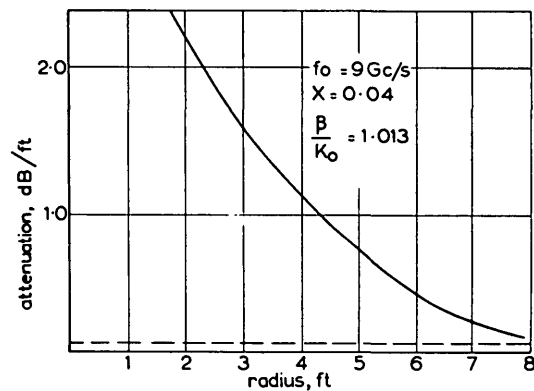

Fig. 14 Experimental bending loss of a fibre carrying the E_0 mode at a frequency of 9 GHz

Table 2: Details of modes photographed

Photo-graph in Fig. 16	Mode	Fibre	Corrected core diameter	Corrected wavelength	Approximate input spot diameter
a	HE_{11}	E	μm 1.80	μm 0.590	μm 1.15
b	EH_{11}	C	4.50	0.560	3.00
c	TM_{02} or TE_{02}	H	8.45	0.553	3.00
d	$TE_{01} + HE_{21}$	D	3.05	0.550	3.00
e	$HE_{12} + EH_{11}$	H	8.45	0.580	3.00
f	$TE_{02} + HE_{22}$	H	8.45	0.545	3.00
g	$TM_{02} + HE_{22}$ or $EH + HE$	H	8.45	0.630	3.00

A preliminary experiment on the butt jointing of two fibres has been carried out. It was observed that, when the fibres were placed with a gap of less than 1 mm, the energy transfer was not less than 10% if a matching fluid was placed in the gap. The first fibre acted as the light source

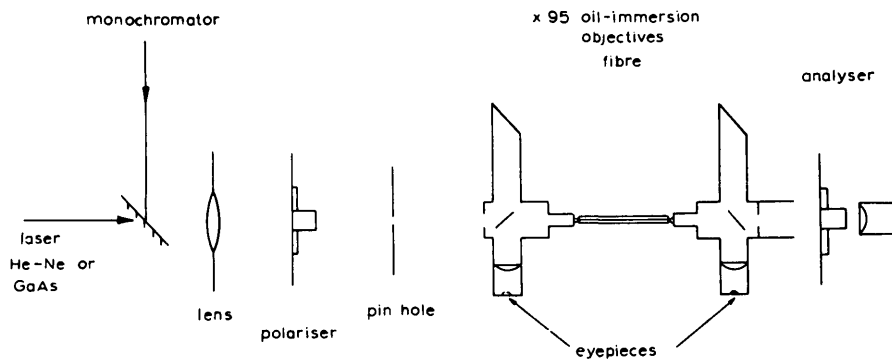

Fig. 15 Schematic diagram of the experimental optical apparatus

for the second fibre; by offsetting the second fibre, different mode patterns from the one carried by the first fibre could

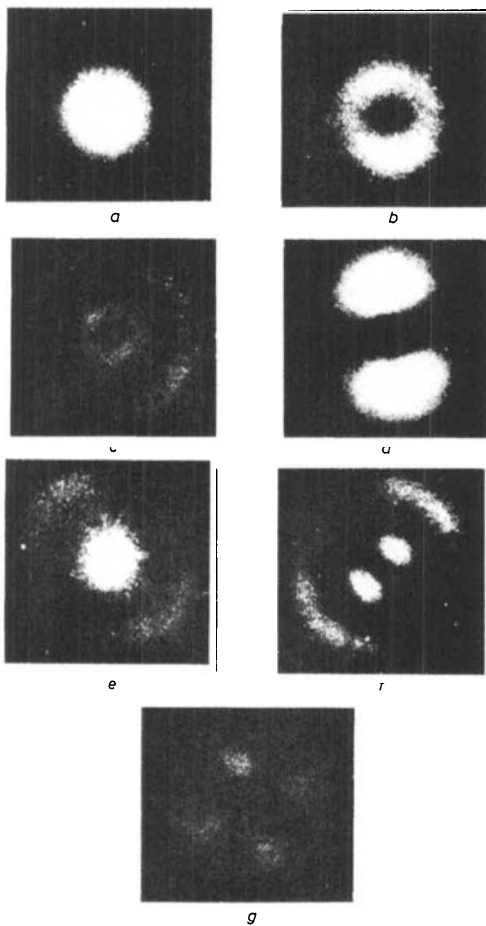

Fig. 16 Photographs of light patterns produced by modes

be observed, if the second fibre was not a single-mode structure.

7 Conclusions

Theoretical and experimental studies indicate that a fibre of glassy material constructed in a cladded structure with a core diameter of about $100 \lambda_0$ represents a possible practical optical waveguide with important potential as a new form of communication medium. The refractive index of

the core needs to be about 1% higher than that of the cladding. This form of waveguide operates in a single HE_{11} , E_0 or H_0 mode and has an information capacity in excess of 1 GHz. It is completely flexible and calls for a mechanical tolerance of around 10%, which can be readily met in practice. Thus, compared with existing coaxial-cable and radio systems, this form of waveguide has a larger information capacity and possible advantages in basic material cost. The realisation of a successful fibre waveguide depends, at present, on the availability of suitable low-loss dielectric material. The crucial material problem appears to be one which is difficult but not impossible. Certainly, the required loss figure of around 20 dB/km is much higher than the lower limit of loss figure imposed by fundamental mechanisms.

8 Acknowledgment

The authors wish to acknowledge the contribution of Mr. R.W. Lomax in carrying out the fibre-mode experiment and dielectric-loss measurements, and to thank Standard Telecommunication Laboratories Ltd. for permission to publish the paper.

9 References

- 1 COLLIN, R.E.: 'Field theory of guided waves' (McGraw-Hill, 1960)
- 2 MAURER, R.D.: 'Light scattering by glasses', *J. Chem. Phys.*, 1956, **25**, p. 1206
- 3 STEELE, F.N., and DOUGLAS, R.W.: 'Some observations on the absorption of iron in silicate and borate glasses', *Phys. Chem. Glasses*, 1965, **6**, (6), p. 246
- 4 GOUBAU, G.: 'Single conductor surface wave transmission line', *Proc. Inst. Radio Engrs*, 1951, **39**, p. 619
- 5 ELLIOTT, R.S.: 'Azimuthal surface waves on circular cylinders', *J. Appl. Phys.*, 1955, **26**, p. 368
- 6 POTTER, S.V.: 'Propagation in the azimuth direction of a cylindrical surface wave', Ph.D. Thesis, University College London, 1963
- 7 BREITHAUPT, R.W.: 'The diffraction of a cylindrical surface wave by surface discontinuities', Ph.D. Thesis, University College London, 1965
- 8 HOCKHAM, G.: 'Surface wave propagation on varying reactive cylindrical structures', Ph.D. Thesis, 1969, University of London
- 9 JONES, A.L.: 'Coupling of optical fibres and scattering in fibres', *J. Opt. Soc. Amer.*, 1965, **55**, p. 261
- 10 SAVARD, J.Y.: 'An investigation of higher order surface waves on cylindrical structures', Ph.D. Thesis, University College, London, 1961
- 11 BARLOW, H.E.M., and KARBOWIAK, A.E.: 'An experimental investigation of the properties of corrugated cylindrical surface waveguides', *Proc. IEE*, 1954, **101**, Pt. III, p. 182